

# EMBLEMS

## *Transportation*

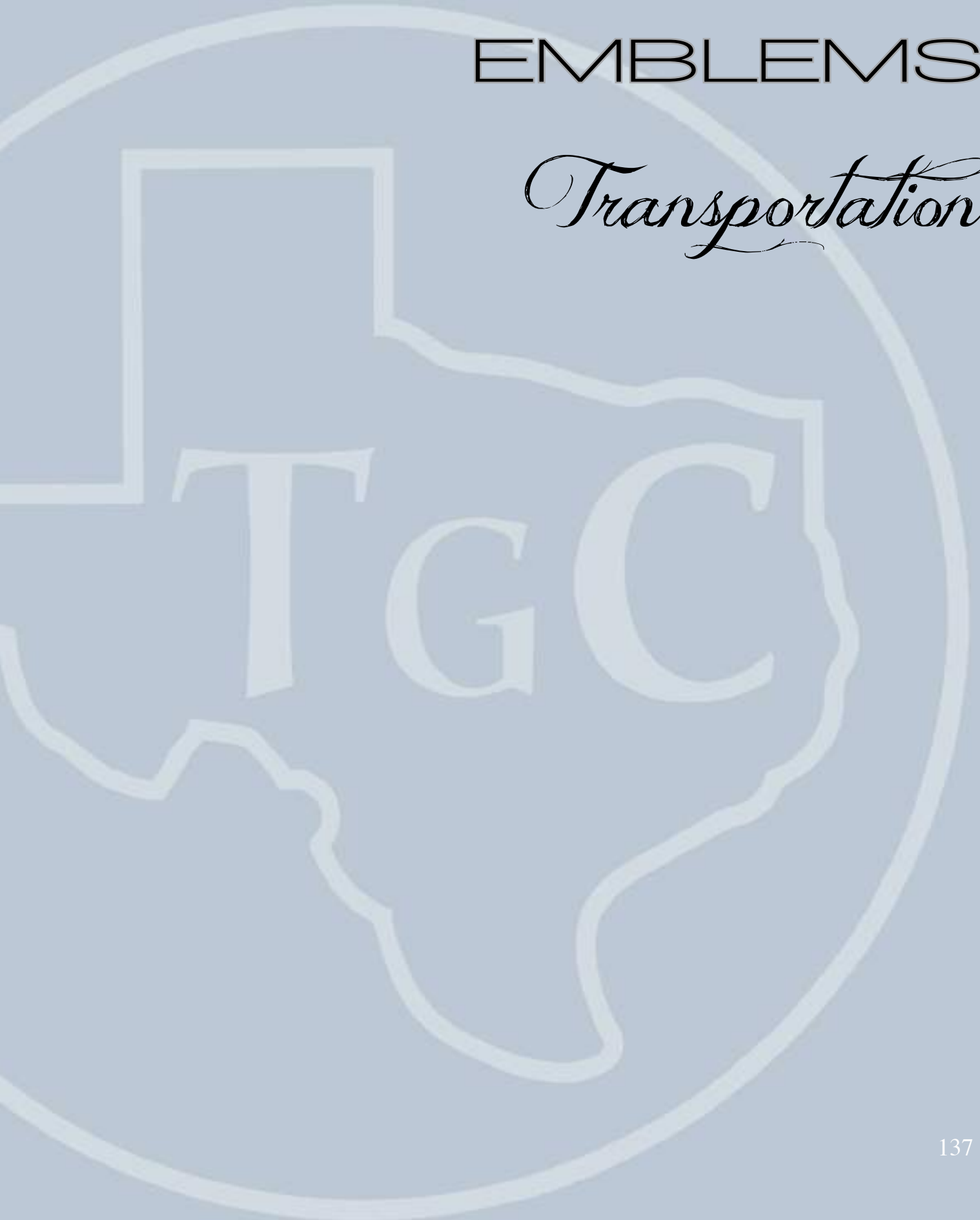

# TRANSPORTATION

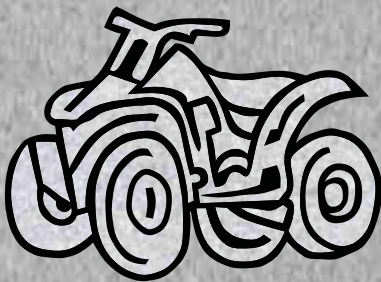

4-WHEELER 01  
6-3/4 X 4-5/8

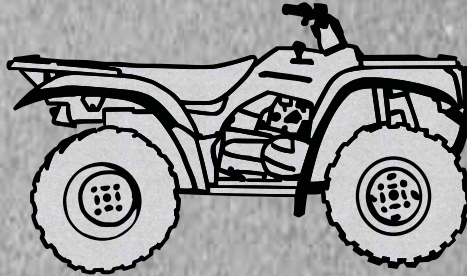

4-WHEELER  
13-5/8 X 6-5/8

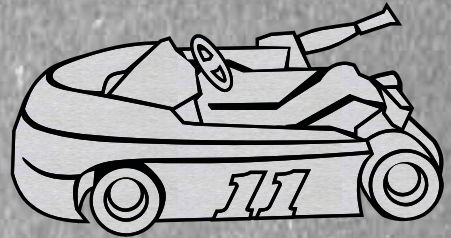

5HP GO KART  
10-5/8 X 5-1/2

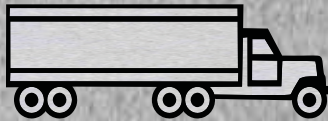

18 WHEELER 05 SMALL  
5-3/8 X 2



18 WHEELER 04 SMALL  
6-5/8 X 3-5/8

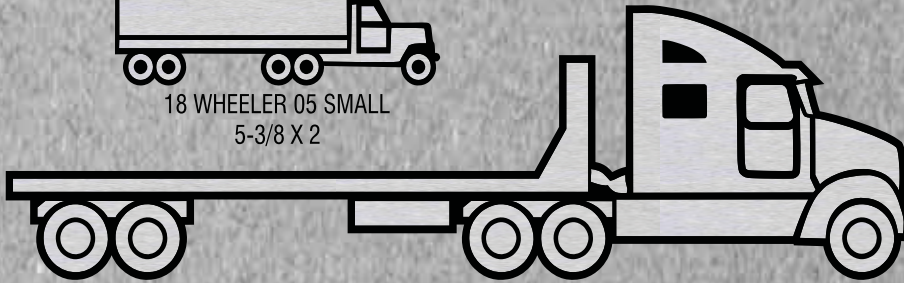

18 WHEELER 01 FLATBED SMALL  
11-1/4 X 3-1/4



18 WHEELER 01 FLATBED  
31-1/2 X 7-1/4

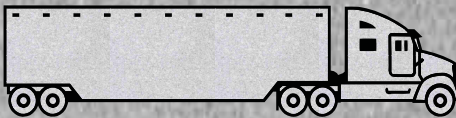

18 WHEELER 03 SMALL  
13-1/8 X 3

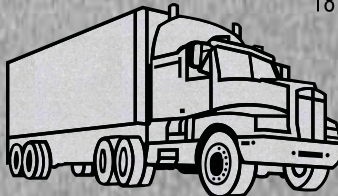

18 WHEELER 04  
9-3/4 X 3-1/8



18 WHEELER 08  
7-3/4 X 4-1/8

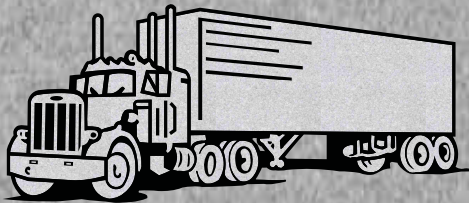

18 WHEELER 06  
13-1/ X 5-1/2

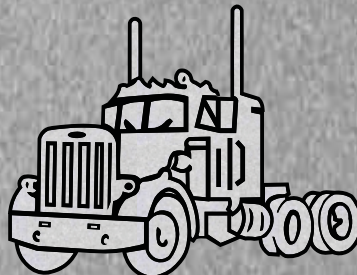

18 WHEELER 07  
13-1/ X 5-1/2



18 WHEELER 10  
5-5/8 X 1-1/4

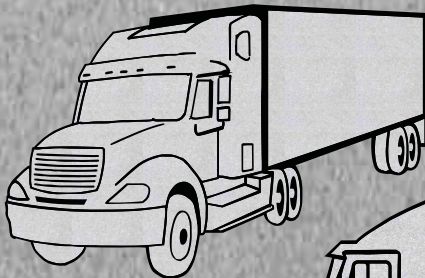

18 WHEELER 09  
12 X 1-1/2

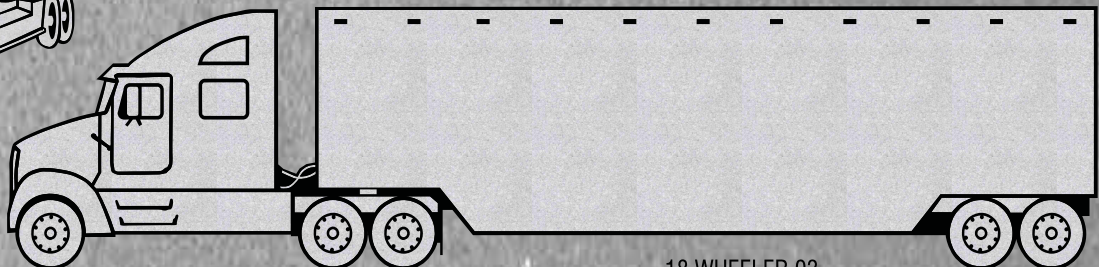

18 WHEELER 03  
31-1/2 X 7-1/4

# TRANSPORTATION

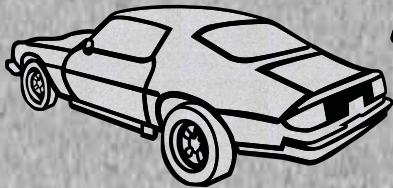

1975 CHEVY CAMARO  
10-7/8 x 5

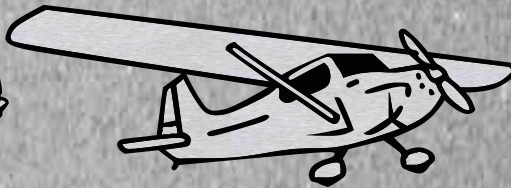

AIRPLANE 01  
10 X 3-1/2



AIRPLANE 02  
8 X 3-5/8

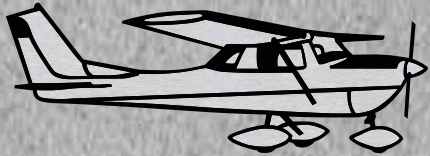

AIRPLANE 04 SMALL  
9 X 3



AIRPLANE 04  
13-1/4 X 4-1/2

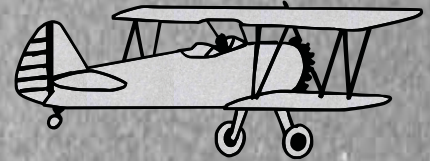

AIRPLANE 07 BI-PLANE  
9-1/2 X 3-5/8

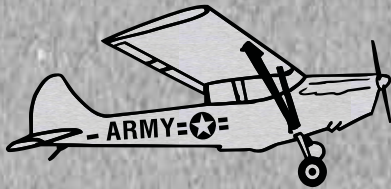

AIRPLANE 08  
9 X 4

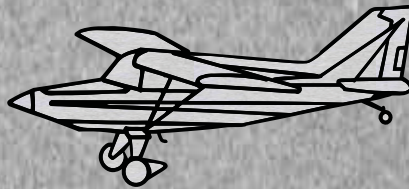

AIRPLANE 09  
9-3/4 X 4-1/4

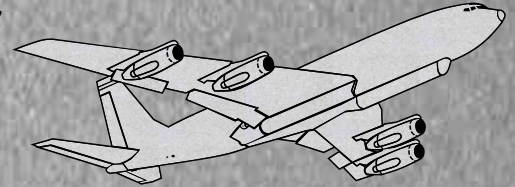

AIRPLANE 13  
37-1/2 X 13

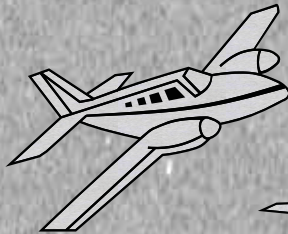

AIRPLANE 16  
10-3/4 X 8

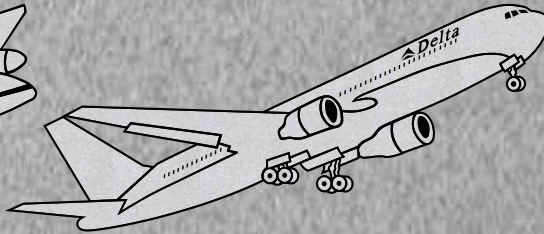

AIRPLANE 17  
28-3/8 X 11-1/4

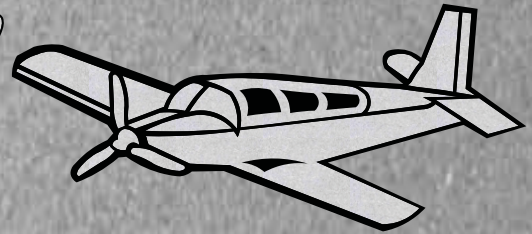

AIRPLANE 18  
10 X 4-1/4

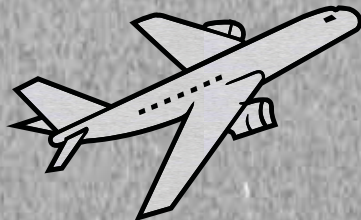

AIRPLANE 19  
7-3/4 X 5-1/2



AIRPLANE GLIDER 01  
12-3/4 X 5-1/2

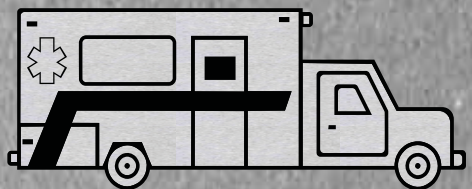

AMBULANCE  
12 X 4

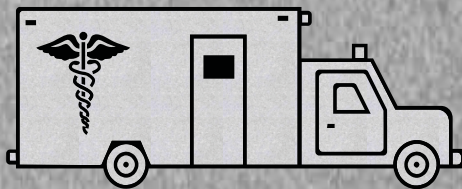

AMBULANCE 00  
13 X 5

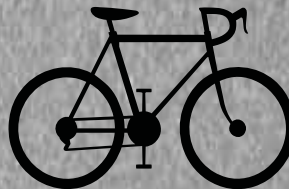

BICYCLE 02  
7-1/2 X 4-1/2

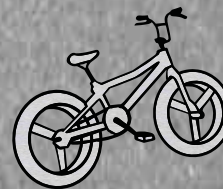

BICYCLE 03-BMX  
7-3/4 X 6



BICYCLE 04  
7-1/2 X 4-3/4

# TRANSPORTATION

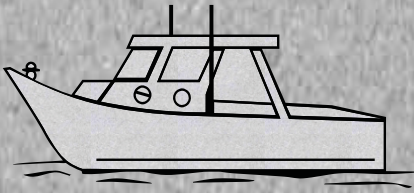

BOAT 01  
18-3/4 X 8

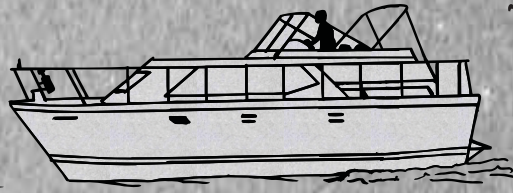

BOAT 02  
14-1/2 X 5

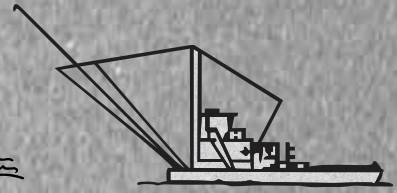

BOAT 03 DREDGE  
9-1/2 X 4-1/2

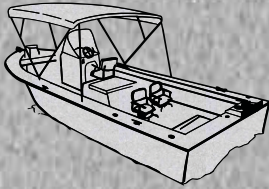

BOAT 04  
16-1/4 X 10-1/2

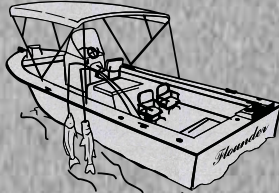

BOAT 05 FISHING  
17-3/8 X 12-1/2



BOAT 06 OUTBOARD  
14-3/4 X 3-1/2

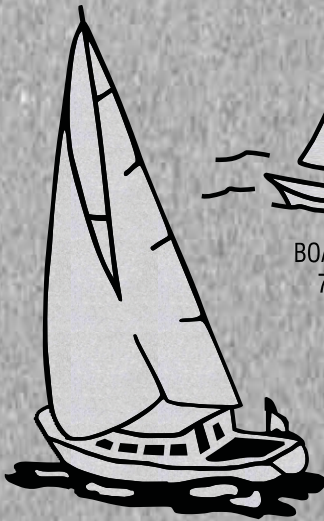

BOAT 09-SAIL  
11-3/4 X 13  
6-1/2 X 10

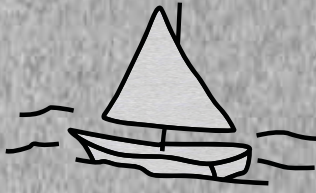

BOAT 10-SAIL  
7-1/2 X 4



BOAT 12-SAIL  
4 X 4



BOAT 14-SAIL  
6-1/4 X 5-3/4

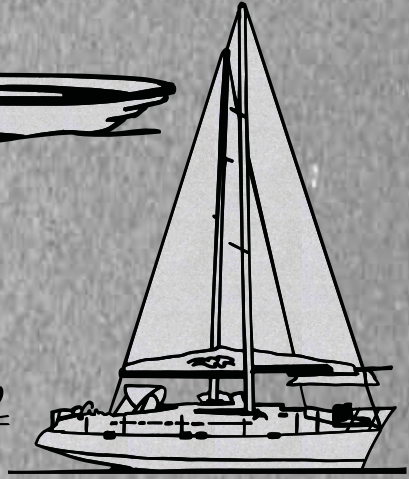

BOAT 08-SAIL  
11-3/4 X 13

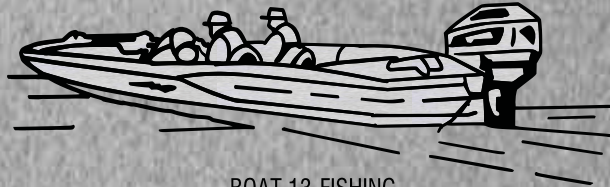

BOAT 13-FISHING  
12-3/4 X 3-1/2

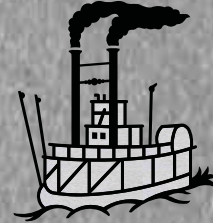

BOAT 15-RIVERBOAT  
8-1/2 X 5-5/8

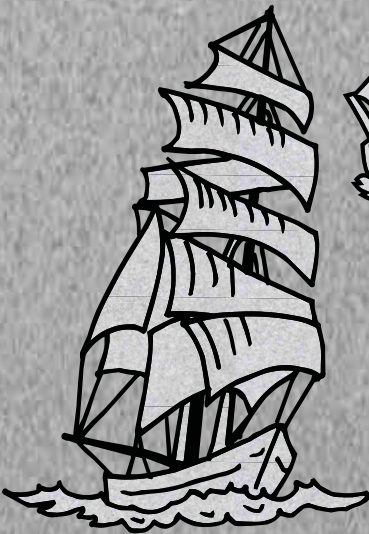

BOAT 16-SAIL  
6 X 8-1/4



BOAT 21-SAIL  
4-1/2 X 6

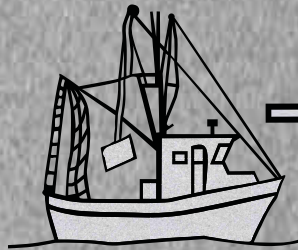

BOAT 22-SHRIMPER  
8-5/8 X 6-3/4



BOAT 19  
9-1/2 X 2-1/2



BOAT 17  
12 X 6-3/4/2



BOAT 20-SAIL  
7 X 9-3/4

# TRANSPORTATION

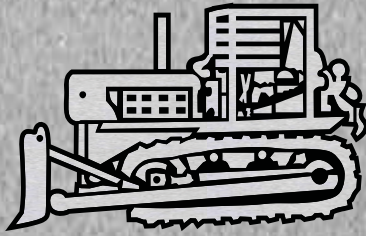

BULLDOZER  
7-3/4 X 4



BULLDOZER 01  
8 X 5

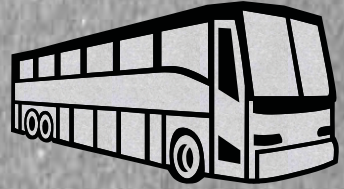

BUS 02  
7 X 3-3/4

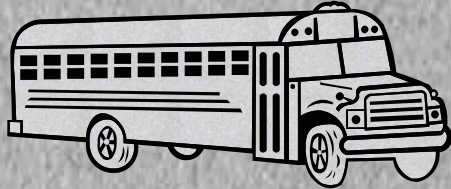

BUS  
22-3/4 X 9-1/8

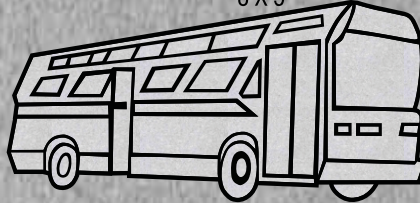

BUS 01  
10-1/2 X 4-3/4



CAMPER  
9 X 4



CAMPER 1  
6-3/8 X 6-3/8

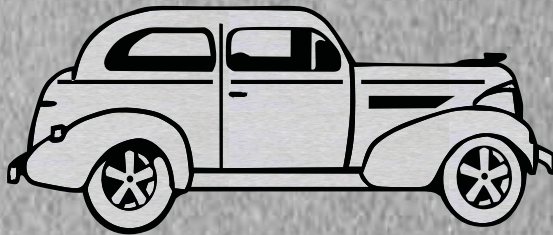

CAR 01 ANTIQUE  
10 X 4  
7 X 3



CAR 02 CRX  
8-1/2 X 4



CAR 03 DUSTER  
6-1/2 X 3-1/4

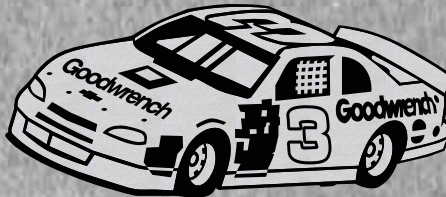

CAR 04  
24 X 9 AND 13 X 5-1/2

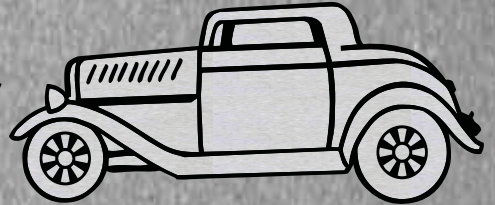

CAR 05 HOT ROD  
9-5/8 X 4

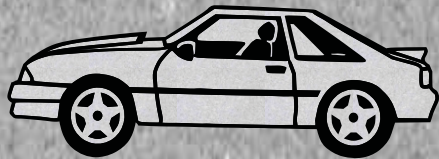

CAR 06 MUSTANG  
9 1/4 X 3-1/8

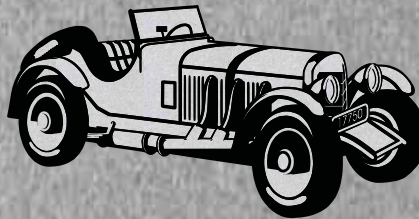

CAR 07 ANTIQUE  
25-3/8 X 12-3/8

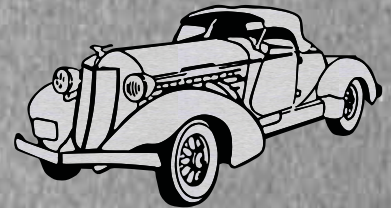

CAR 08 ANTIQUE  
9-1/4 X 5

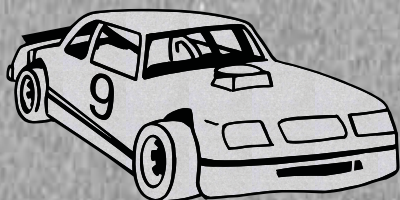

CAR 09  
12-5/8 X 6-1/2

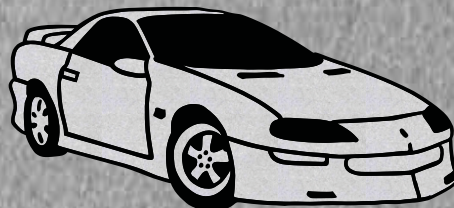

CAR 11 CAMARO  
9 X 4

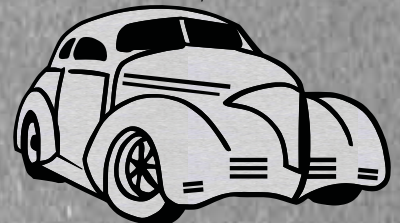

CAR 12 HOT ROD  
9 X 5

# TRANSPORTATION

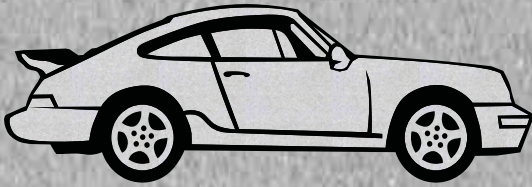

CAR 13 PORSCHE  
13-1/8 X 4-1/4

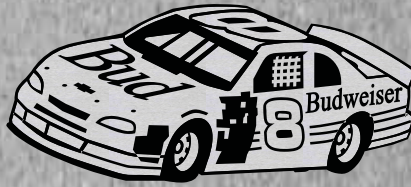

CAR 14 BUDWEISER RACE CAR  
17 X 7

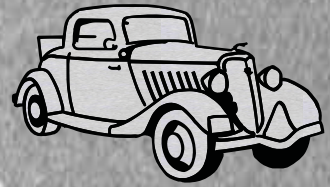

CARE 15 ANTIQUE FORD  
9 X 5



CAR 16 HUMMER  
5-5/8 X 3



CAR 20-66 GTO  
9 X 3-3/4

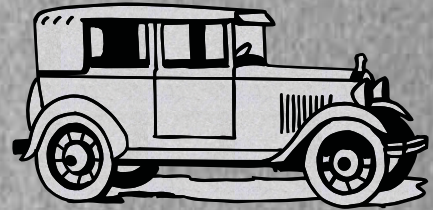

CAR 21 MODEL A FORD  
8-5/8 X 4

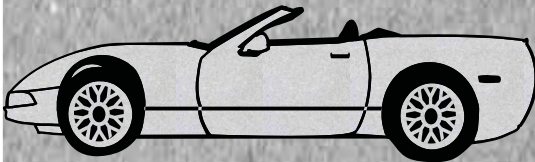

CAR 22 CORVETTE 1  
16 X 4-1/2

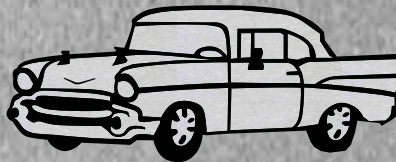

CAR 23-57 CHEVY  
9-1/2 X 3-1/2

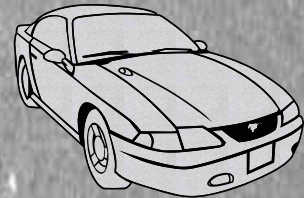

CAR 25-90'S MUSTANG 11-1/2 X 7-1/4

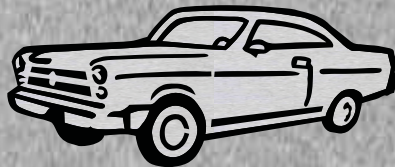

CAR 26  
8 X 3

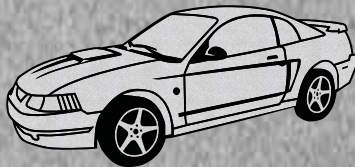

CAR 27 -94 MUSTANG  
20 X 8-3/4

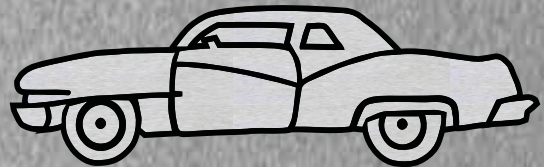

CAR 28  
10 X 3

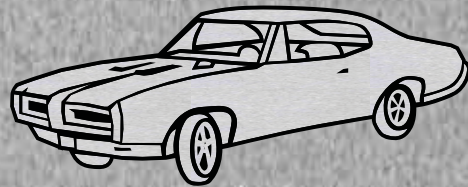

CAR 29 GTO  
10-1/2 X 4

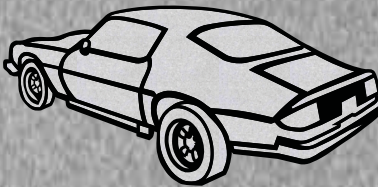

CAR 30-1975 CHEVY CAMARO  
11 X 5

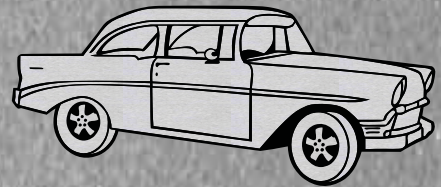

CAR 31-56 CHEVY  
15-3/4 X 6-1/2

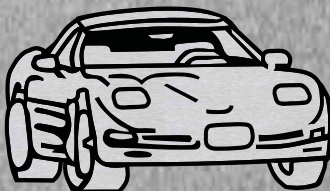

CAR 32  
8-14 X 4-1/2



CAR 33 CORVETTE  
11 X 4-1/4

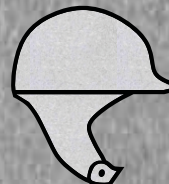

CROMWELL HELMET  
4-1/4 X 4-1/2



DUMP TRUCK 01  
8-1/4 X 6-1/2

# TRANSPORTATION



DUMP TRUCK 02  
17 X 10 AND 11-1/2 X 6-3/4

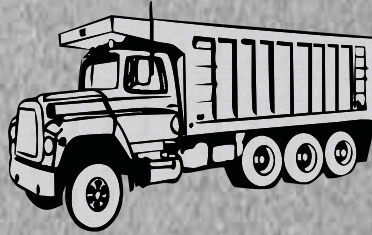

DUMP TRUCK 03  
21 X 12-1/2



DUMP TRUCK 04  
6-1/4 X 3-1/2

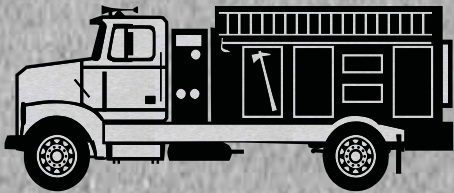

FIRETRUCK 01  
14 X 5-1/2

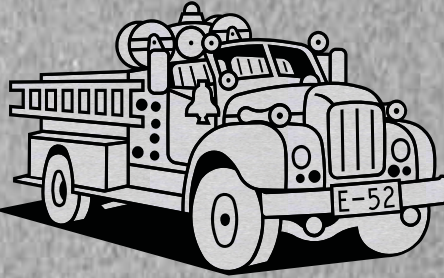

FIRETRUCK 02  
9 X 3-3/4



HELICOPTER 01  
11 X 5

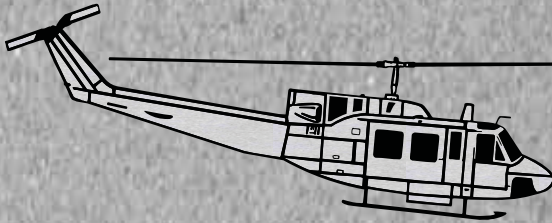

HELICOPTER 03  
22-1/4 X 6-3/4



HELICOPTER 04  
12 X 6



HOT AIR BALLOON  
5 X 7

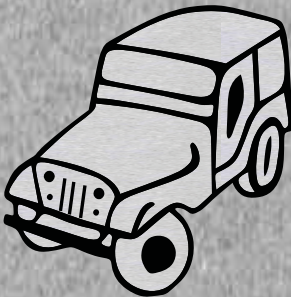

JEEP  
5-1/2 X 2-1/4

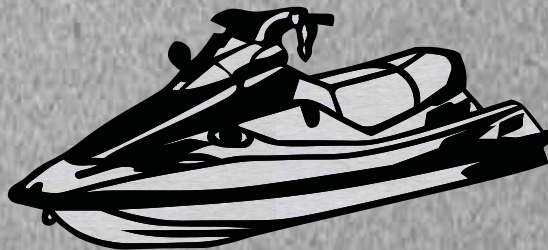

JET SKI  
8-3/4 X 3-3/4

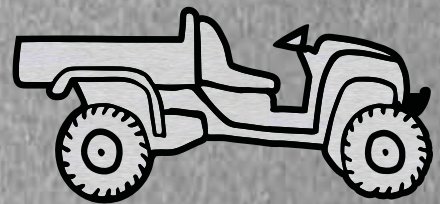

JOHNDEERE GATOR  
6-3/4 X 3

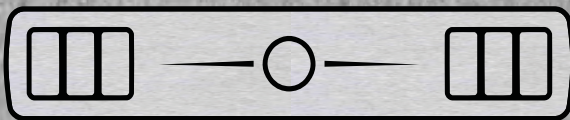

OLDER MODEL MUSTANG TAIL LIGHTS  
8 X 1-1/2

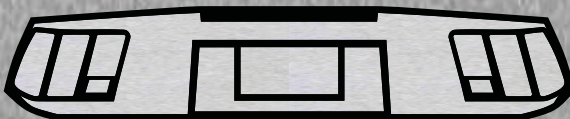

LATE MODEL MUSTANG TAIL LIGHTS  
8-1/2 X 1-1/2

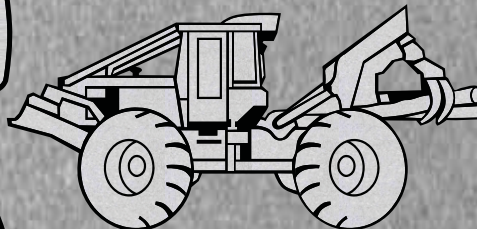

LOG PICKER  
20-1/2 X 9-1/4

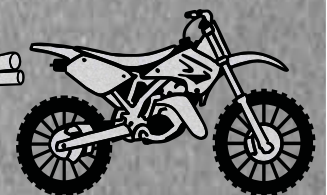

MOTORCYCLE 01 DIRT BIKE  
8-1/4 X 6-1/2

# TRANSPORTATION

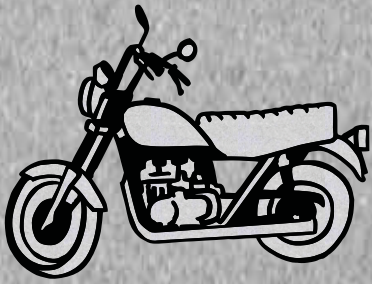

MOTORCYCLE 02  
8-3/4 X 6-1/4

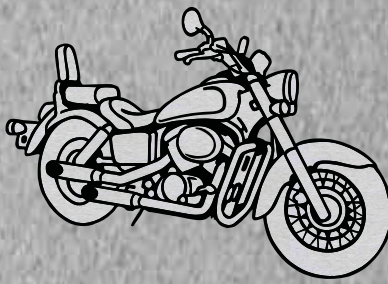

MOTORCYCLE 03 -H.D.  
12 X 8 AND 8-1/4 X 5-3/8

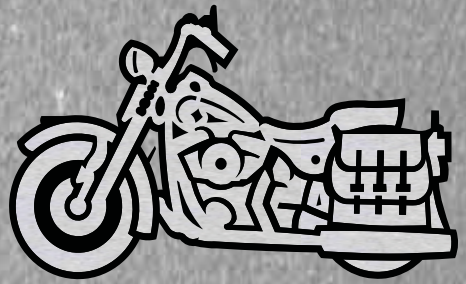

MOTORCYCLE 04  
6-3/4 X 4 AND 6 X 3-1/2

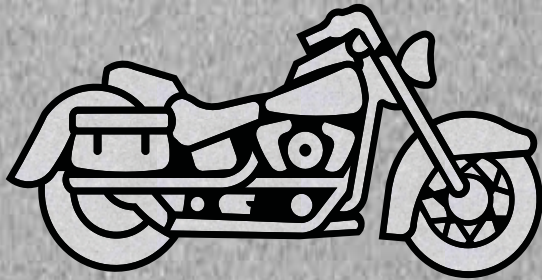

MOTORCYCLE 05  
7-1/2 X 3-5/8

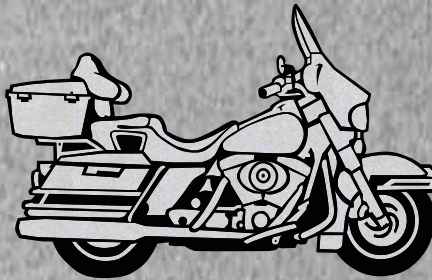

MOTORCYCLE 07  
12-1/8 x 7-1/4

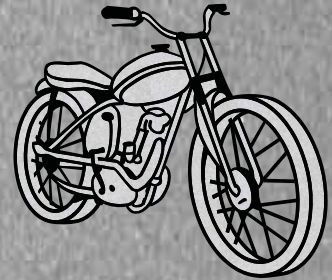

MOTORCYCLE 08  
8-1/8 x 6-3/4

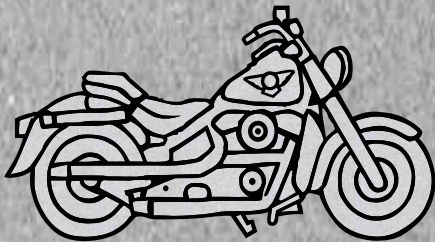

MOTORCYCLE 09  
8-5/8 x 4-1/2

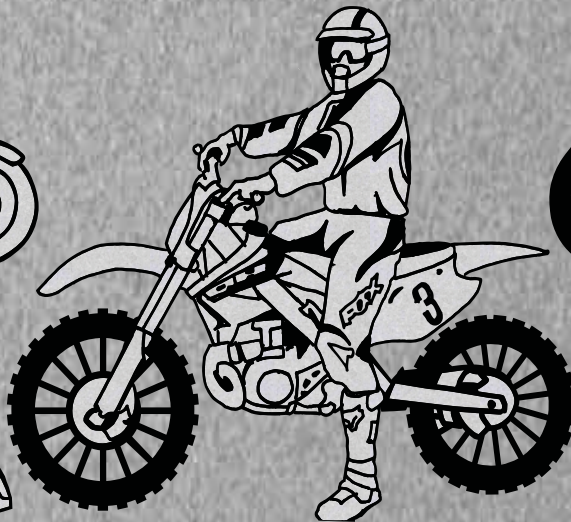

MOTORCYCLE AND RIDER  
10-3/8 X 9



MOTORCYCLE 11  
3 x 2

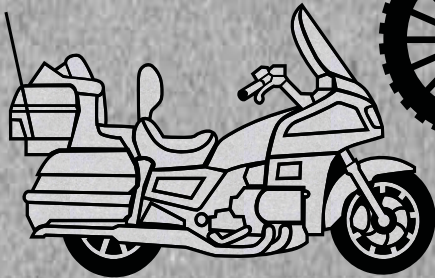

MOTORCYCLE 13 HONDA GULLWING  
14 X 8-1/2

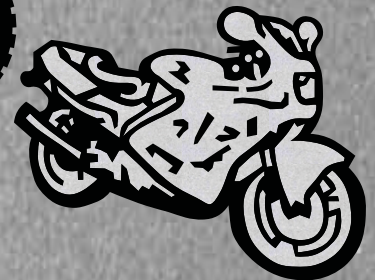

MOTORCYCLE 12  
8 x 6

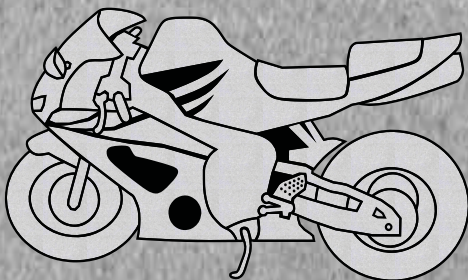

MOTORCYCLE HONDA CBR  
21-1/2 X 12

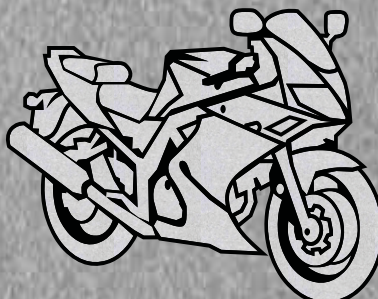

MOTORCYCLE SUZUKI SV-650  
8-1/2 X 6-1/4

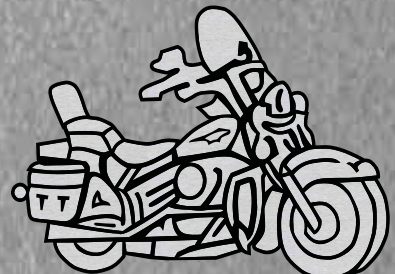

MOTORCYCLE 10  
11-3/8 x 7-3/4



# TRANSPORTATION

MOTOGRADER  
10-5/8 X 4-1/2



PULP WOOD TRUCK  
12-3/4 X 3-1/2



BICYCLE  
12 X 10

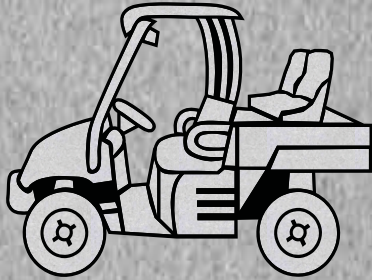

POLARIS RANGER  
12 X 8-1/2

RIDING LAWN MOWER  
10-3/4 X 6-9/4

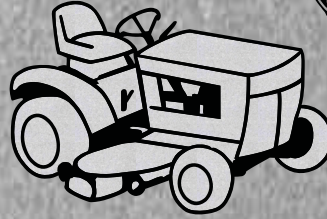

RACE CAR  
5-1/2 X 2-1/4



CORPORATE JET  
13 X 7-1/4

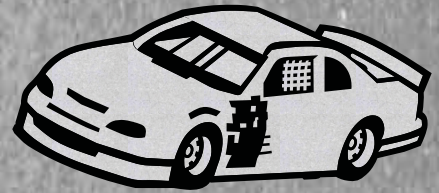

R-R CROSSING  
11-3/8 X 8-1/2

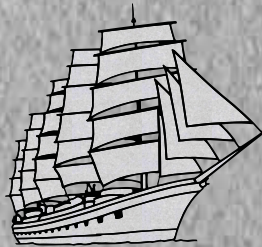

SAILBOAT  
10-1/2 X 9-1/4



SCHOOL BUS  
7 X 5-3/8

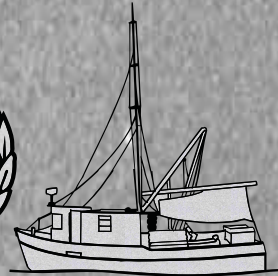

SHRIMP BOAT  
10-5/8 X 10



SHUTTLE 01  
2-1/2 X 6-1/2



SCHOOL BUS 02  
6 X 4-1/4

GLIDER PLANE  
7 X 2-1/2

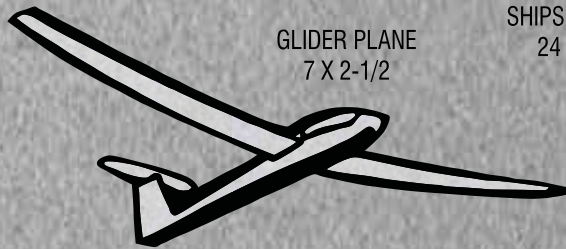

SHIPS WHEEL  
24 X 24

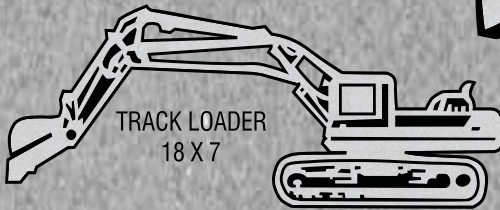
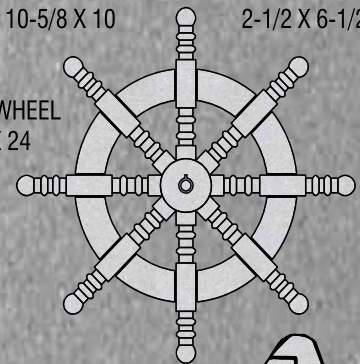

TRACK LOADER  
18 X 7

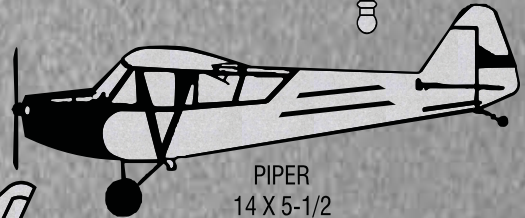

PIPER  
14 X 5-1/2

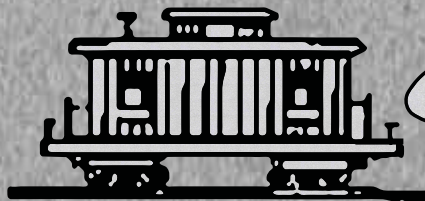

CABOOSE  
10 X 5

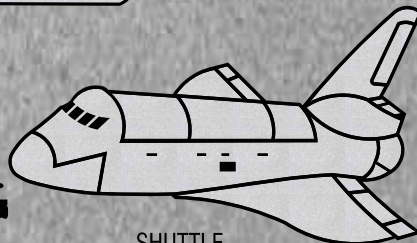

SHUTTLE  
15 X 8-1/4



SNOWMOBILE  
14 X 5-1/2

# TRANSPORTATION

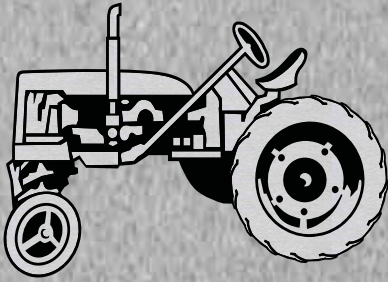

TRACTOR 01  
14-1/4 X 10

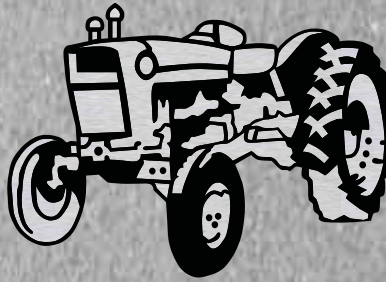

TRACTOR 02  
4-5/8 X 3-1/4



TRACTOR 03  
7-1/4 X 6



POLARIS RANGER  
12 X 8-1/2

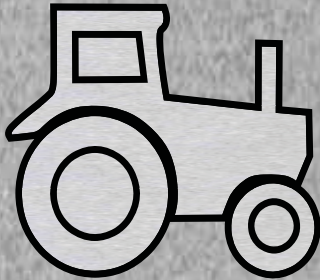

TRACTOR 05  
4 X 3-3/8

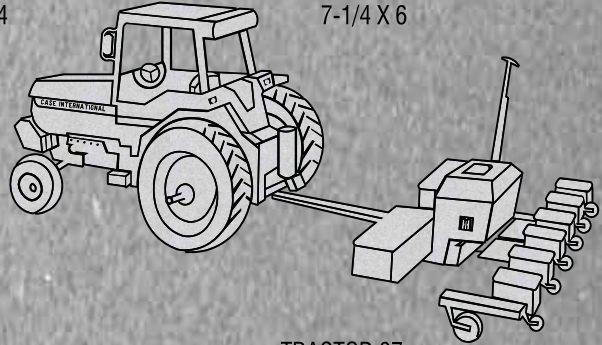

TRACTOR 07  
33-5/8 X 18-1/2

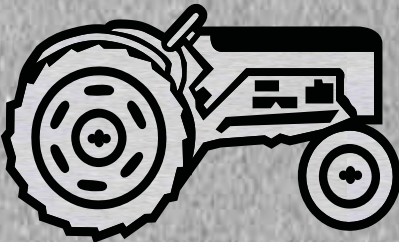

TRACTOR 08  
4-3/4 X 2-5/8

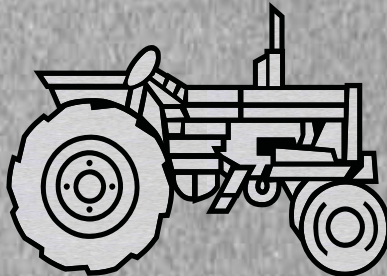

TRACTOR 09  
8 X 5-1/2



TRACTOR 10  
10-3/4 X 5-1/4

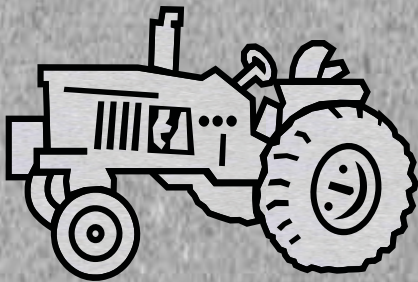

TRACTOR 11  
7 X 4-1/2

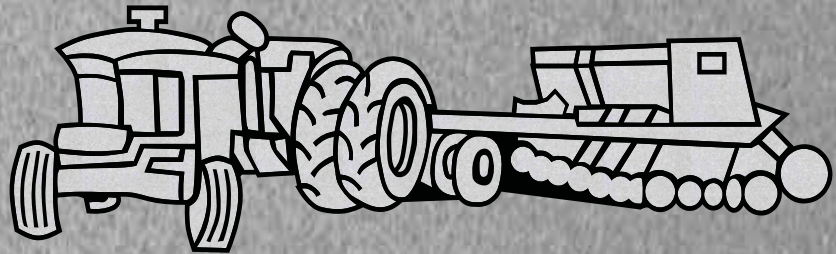

TRACTOR JOHN DEERE AND DRILL  
18-1/2 X 5-1/4

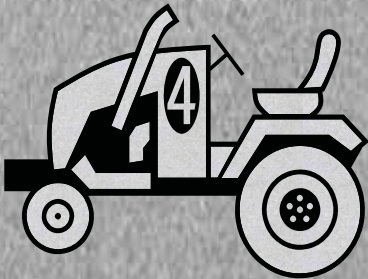

TRACTOR  
8 X 5-1/2

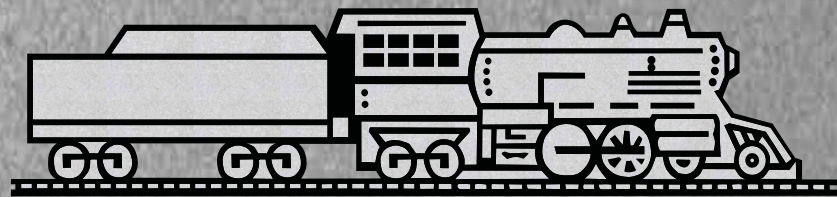

TRAIN 01  
18-3/4 X 4

# TRANSPORTATION

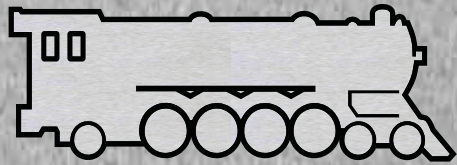

TRAIN 02  
4-1/2 X 1-1/2

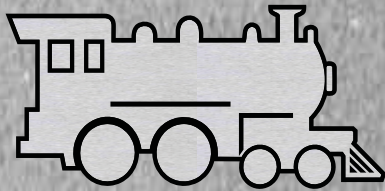

TRAIN 03  
8-1/4 X 3-7/8

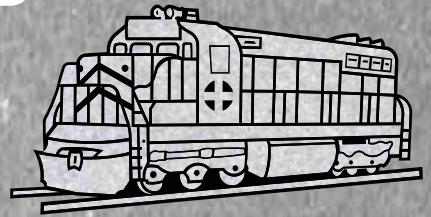

TRAIN 07  
17-1/2 X 9

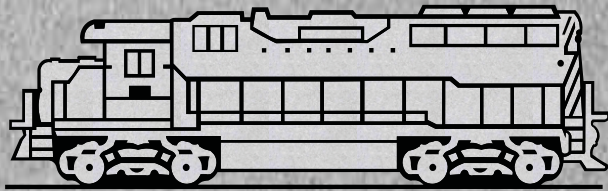

TRAIN 08  
20 X 5-3/4

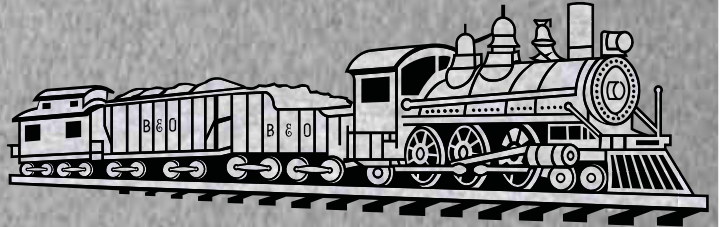

TRAIN 05  
23-1/4 X 7

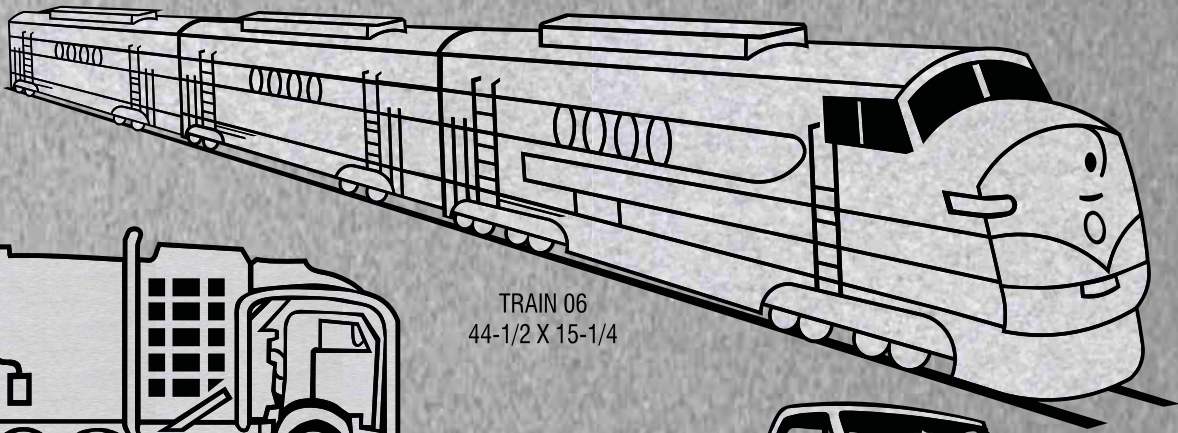

TRAIN 06  
44-1/2 X 15-1/4



TRASH TRUCK  
9-3/4 X 5-3/4



TRUCK 02 CHEVY  
13 X 5

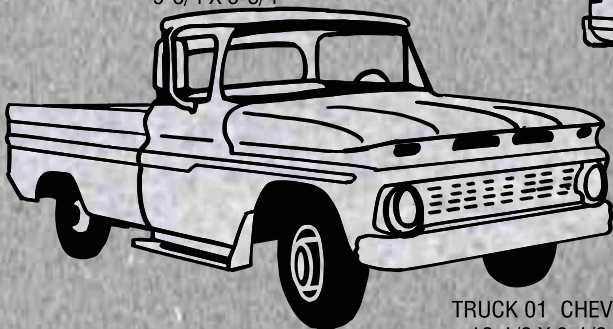

TRUCK 01 CHEVY  
12-1/2 X 3-1/2

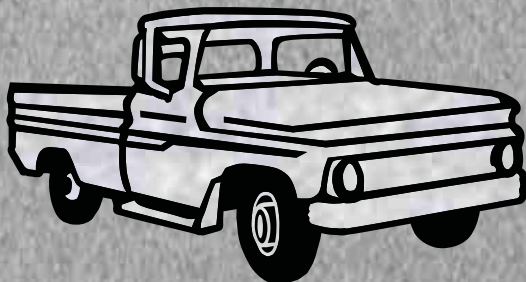

TRUCK 01 CHEVY SMALL  
7 X 3-1/2

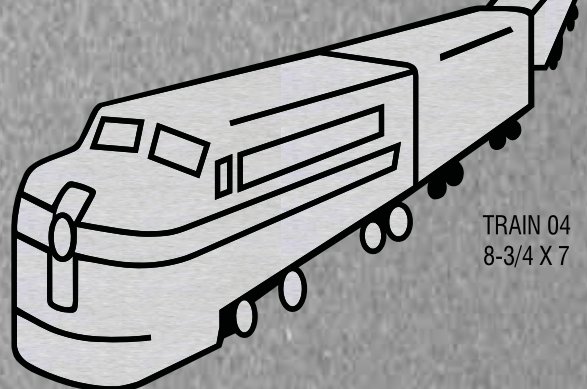

TRAIN 04  
8-3/4 X 7

# TRANSPORTATION

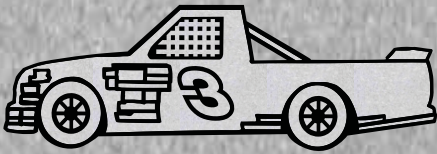

TRUCK 03 CRAFTSMAN  
10-1/4 X 3-3/4

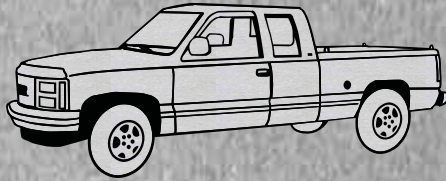

TRUCK 04 GMC  
17 X 7 AND 10 X 4

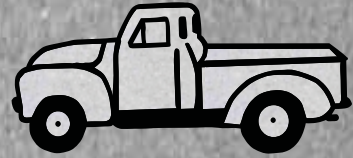

TRUCK 05 ANTIQUE  
3-3/4 X 1-3/4

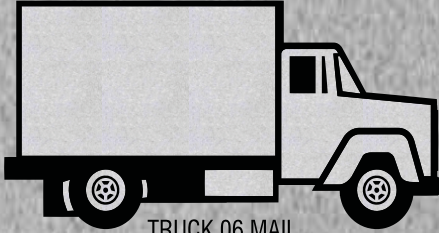

TRUCK 06 MAIL  
8 X 4

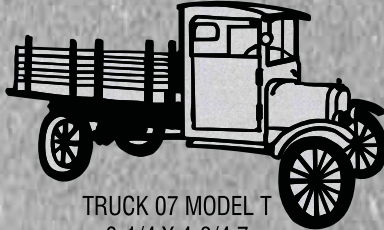

TRUCK 07 MODEL T  
8-1/4 X 4-3/4

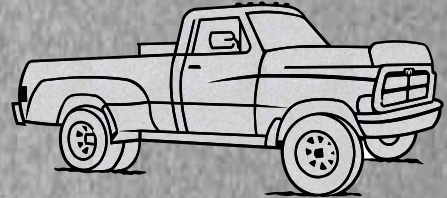

TRUCK 08 DUEL TIRE  
13-1/2 X 5-3/4

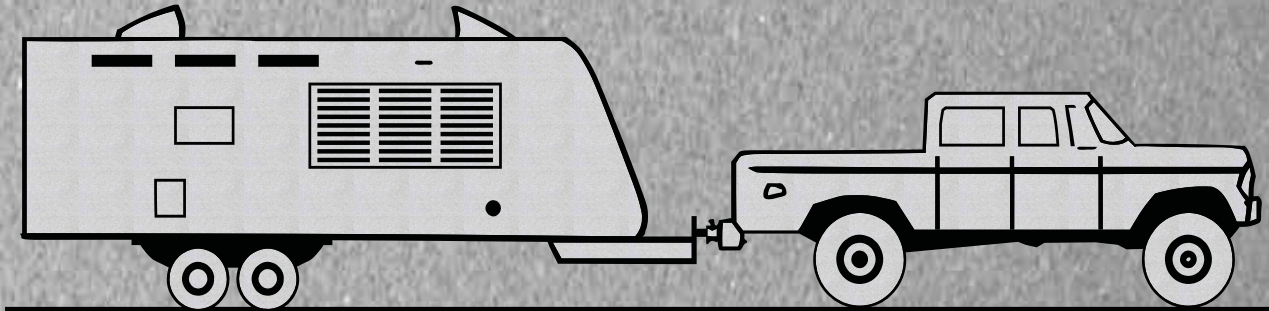

TRUCK 10 WITH CAMPER  
46-1/2 X 10-3/4

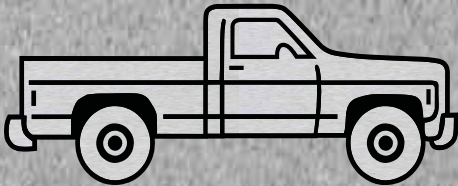

TRUCK 09  
8 X 3

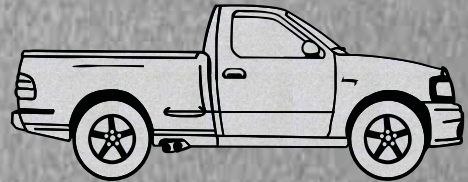

TRUCK 12 FORD LIGHTNING  
13-1/2 X 5

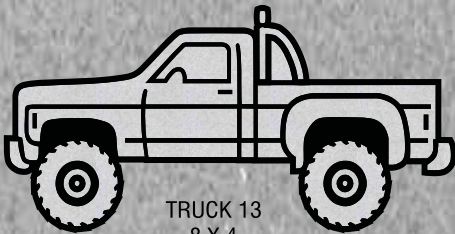

TRUCK 13  
8 X 4

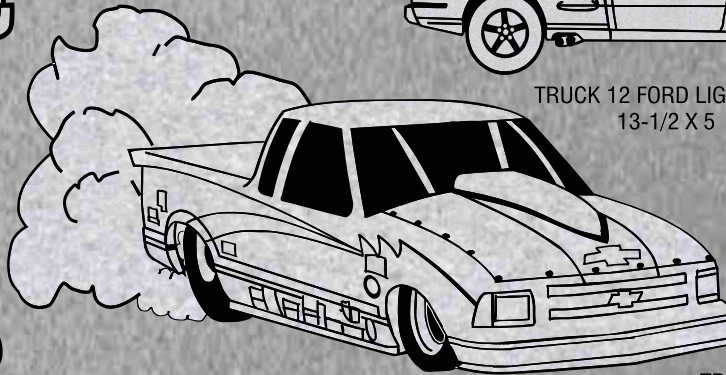

TRUCK 11  
24 X 11-3/4

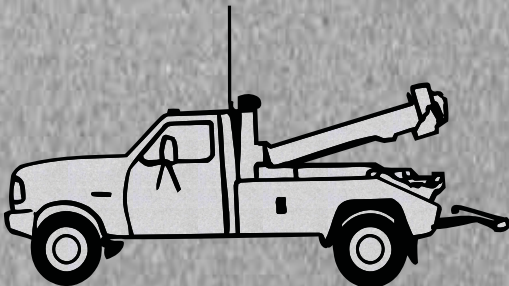

WRECKER 01  
18 X 8-1/2 AND 9 X 5



WRECKER 02  
11-1/2 X 5-1/2